

**Montageanleitung  
DORMA ARCOS  
Stossgriff**

**Installation instructions  
DORMA ARCOS  
handle bar**

**Wichtige Informationen:**  
**Important Information:**

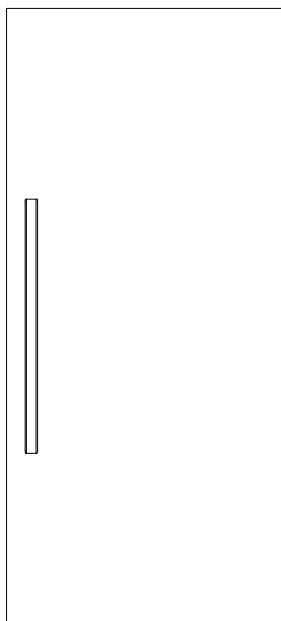

① = Bauteil/Baugruppe  
 Component

1. ; 1.1 ; ... = Montagefolge  
 Mounting sequence

Vor der Montage Glasflächen  
 mit handelsüblichem Glasreiniger  
 im Bereich der Klemmflächen reinigen.

All glass clamping areas have to  
 be cleaned with standard glass  
 cleaning products prior to installation.



keine Verdünnung verwenden  
 Do not use thinners

**Glasbearbeitung Art. Nr.: 26.510:**  
**Glass preparation of Art. No.: 26.510:**

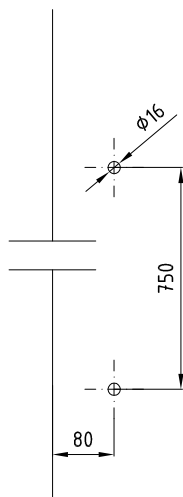

**Glasbearbeitung Art. Nr.: 26.500:**  
**Glass preparation of Art. No.: 26.500:**

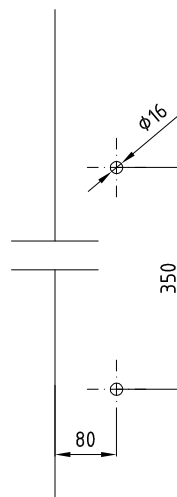

**Montagewerkzeug:**  
**Installation tool:**

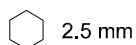

**1. Vorbereitung:**

**1. Preparation:**



Vormontiert für 12mm Glasdicke.  
Preassembled for 12mm glass thickness.

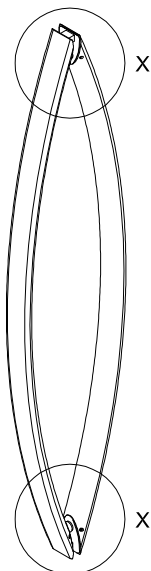

## Detail X

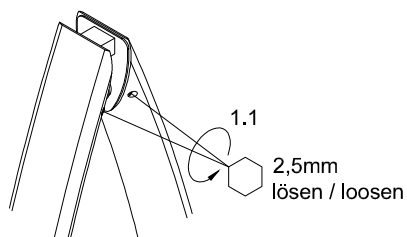

1.3 Holz-/ Kunststoffklötze entsorgen  
1.3 Dispose the spacer

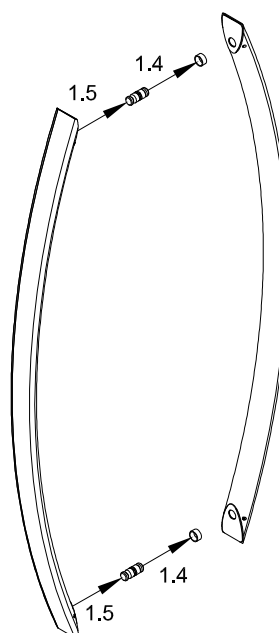
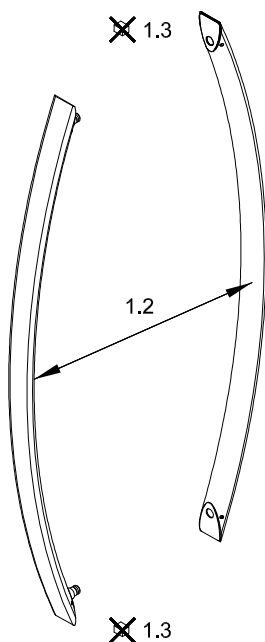

**2. Anpassen auf Glasdicke:  
2. Adapt to glass thickness:**

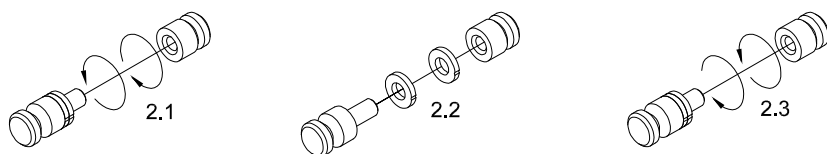

2.2

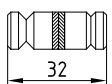
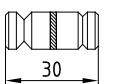
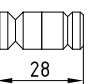
Glas / glass	12 mm Lieferzustand / delivery condition	10 mm	8 mm
Bolzen / bolt	 32	 30	 28

**3. Montage der Verbindungsbolzen:  
3. Assembly of the connection bolt:**

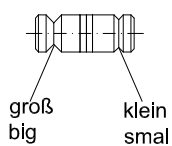

**Detail X**

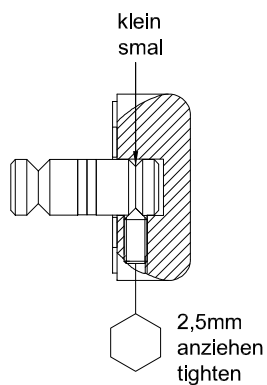
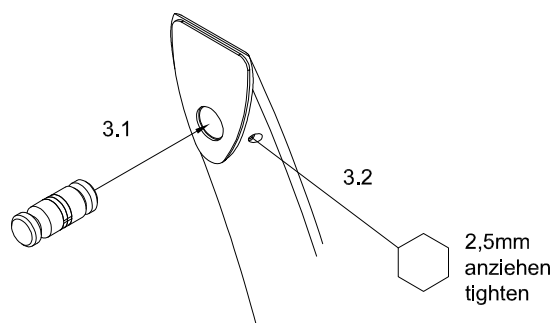
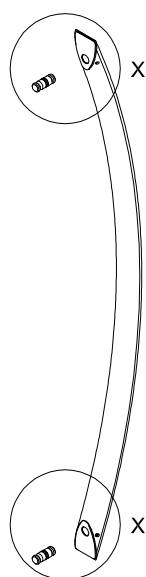

**4. Montage des Stossgriffs:**  
**4. Installation of handle bar:**

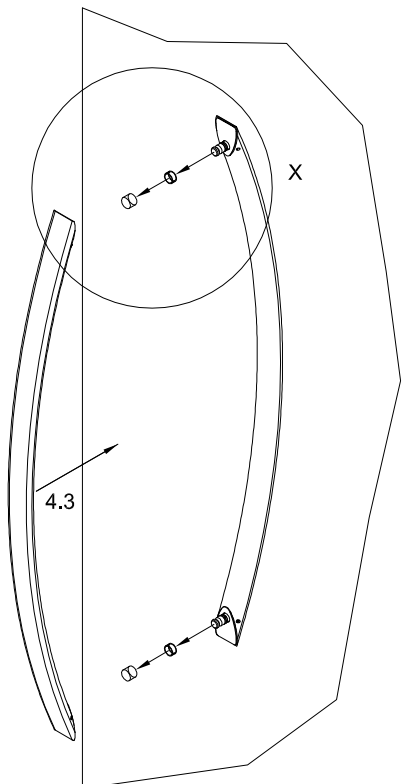

**Detail X**

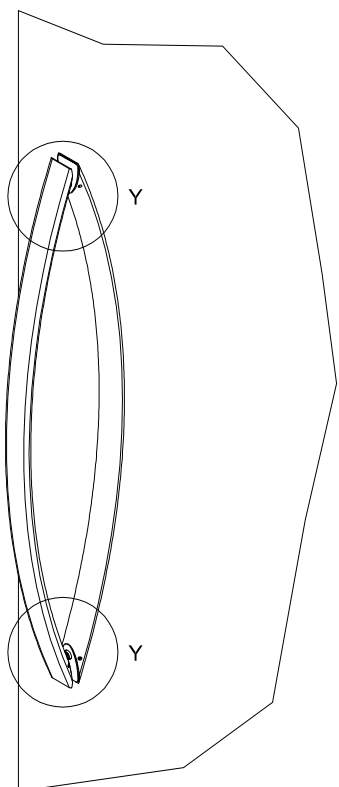
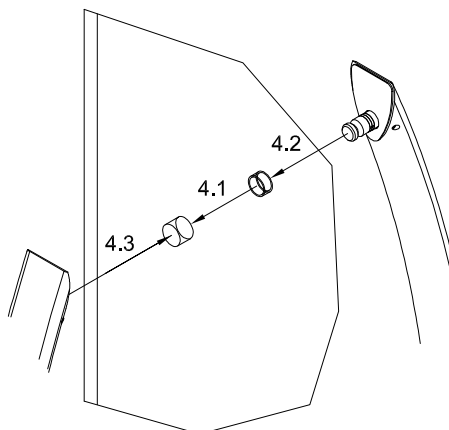

**Detail Y**

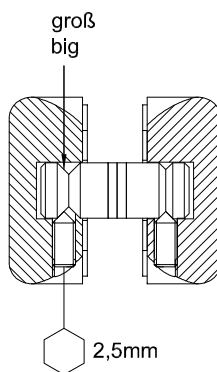
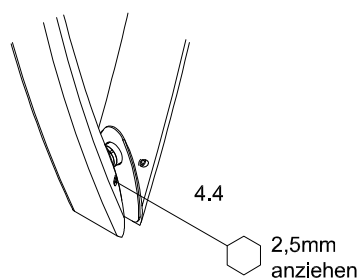

4.4 anziehen, Bolzen spannen  
 4.4 tighten, clamp the bolt